

ETL LED Panel Light (DLC4.2 Premium)



Product Description

- **PF \geq 0.90, Power Efficiency > 0.88, CRI > 80;**
- **Perfect Light Uniformity, LM-80-rated SMD2835 LED Chips, Up to 130LM/W ;**
- **Saving more than 80% energy compared with traditional grid fixtures.**
- **Light Guide Panel in 3mm thickness, imported from Taiwan;**
- **5 years warranty.**

Dimension

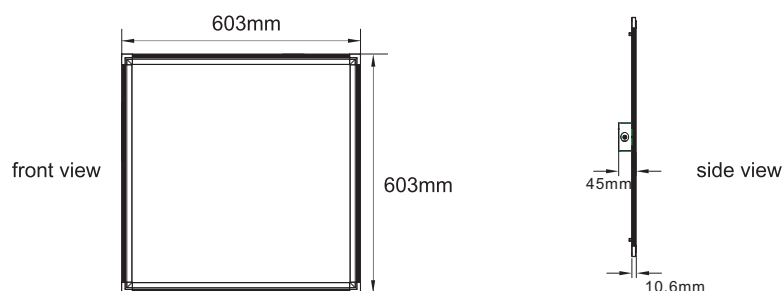

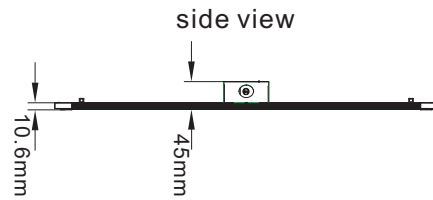
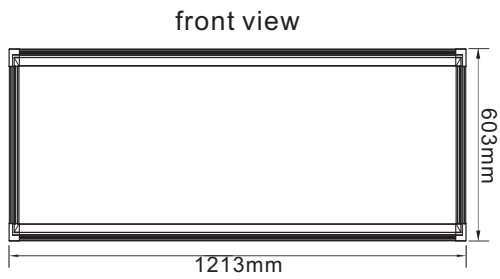
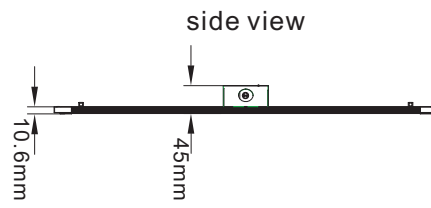
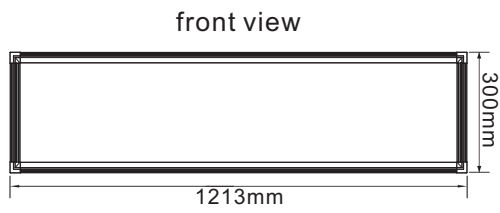

Product Specification

Size(Ft)	2X2		1X4		2X4		
Power Consumption(W)	30	36	30	36	40	48	60
Lumen Output(LM)	3900 ±5%	4680 ±5%	3900 ±5%	4680 ±5%	5200 ±5%	6240 ±5%	7800 ±5%
Light Efficacy (lm/W)	130 ±5%						
CCT(K)	3045±175K 3465±245K 3985±275K 4503±243K 5028±283K						
Color Rendering Index(CRI)	>80						
AC Input Rating(Vac)	AC 100-277V 50/60Hz						
Dimming(Non-dimming,0-10V)	Optional						
PF	≥0.90						

Photometric Data&Diagram

2X2 LUMINOUS INTENSITY DISTRIBUTION DIAGRAM

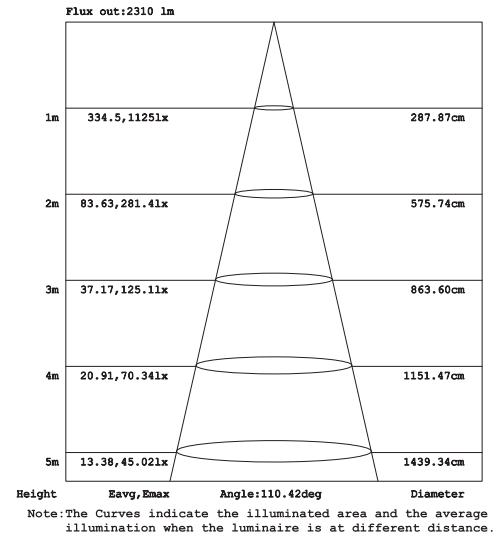
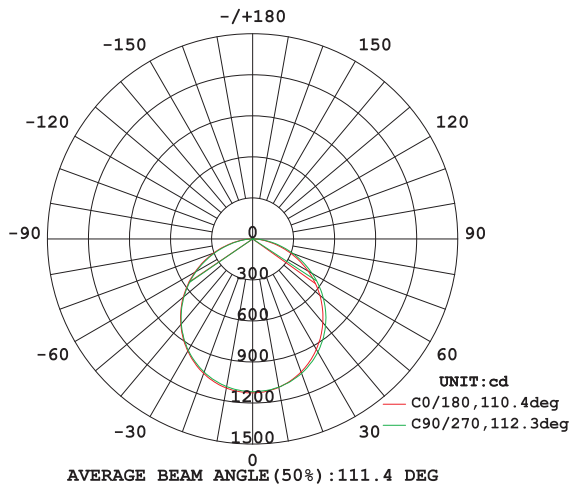

1X4 LUMINOUS INTENSITY DISTRIBUTION DIAGRAM

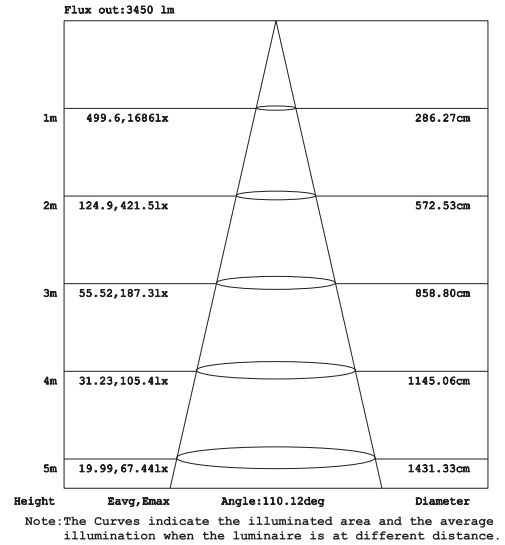
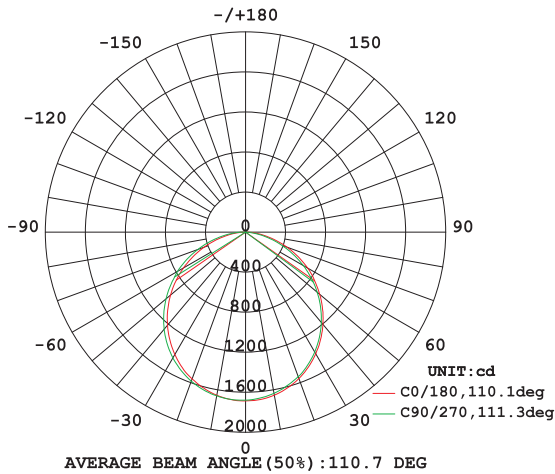

2X4 LUMINOUS INTENSITY DISTRIBUTION DIAGRAM

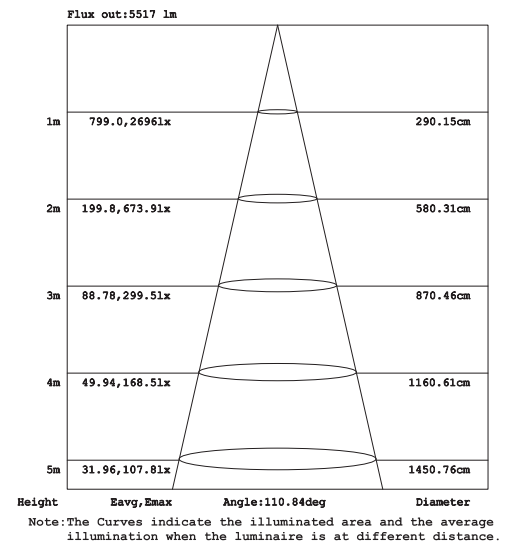
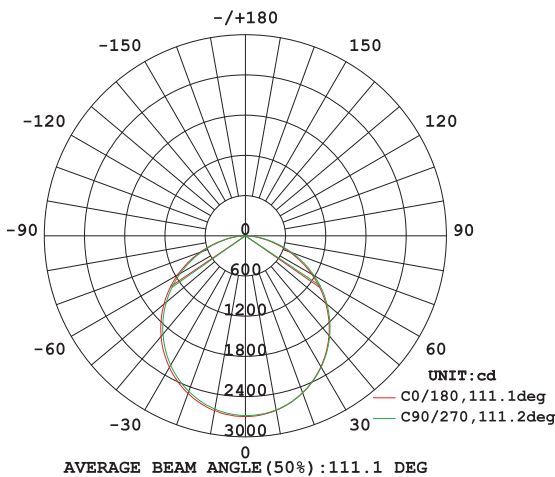

Luminous Decay Graph

Data Set 1, 55°C, 60mA (Chromaticity Shift)

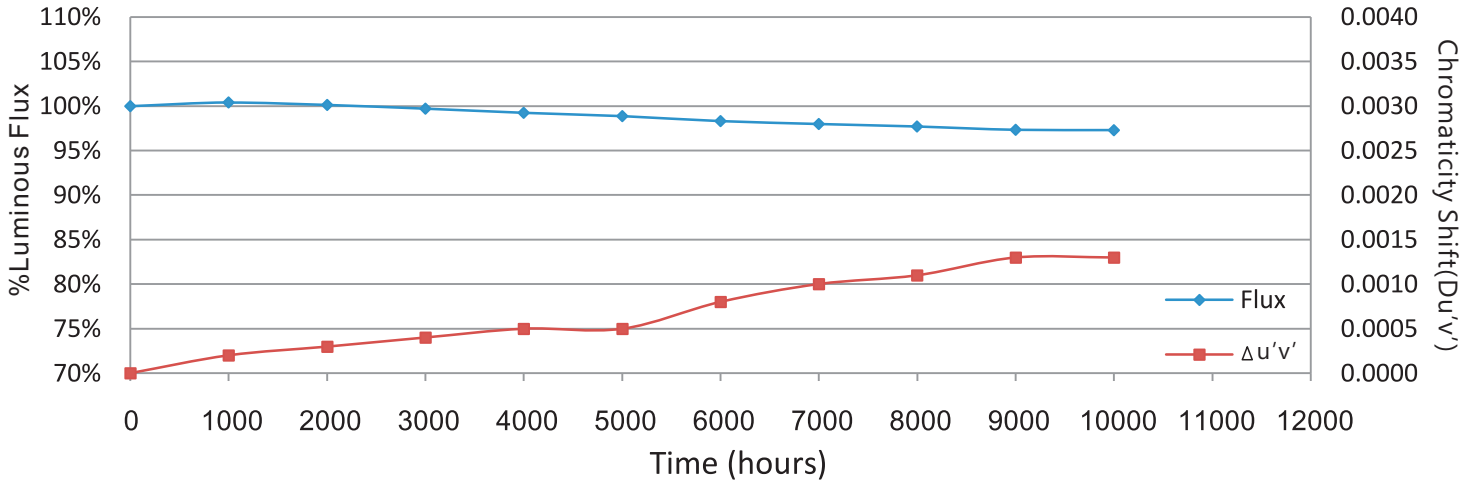

Connection Mode

Dimming Driver

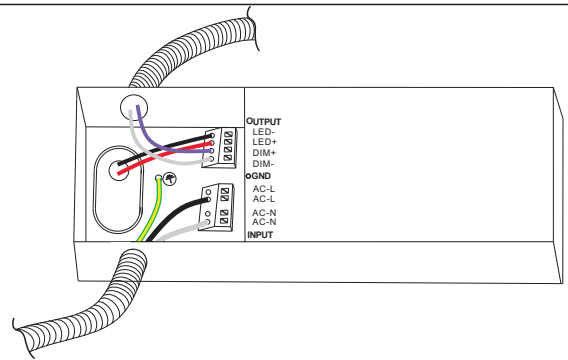
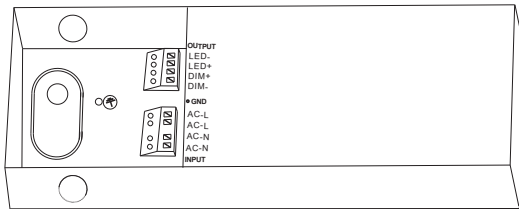

Non-dimmable Driver

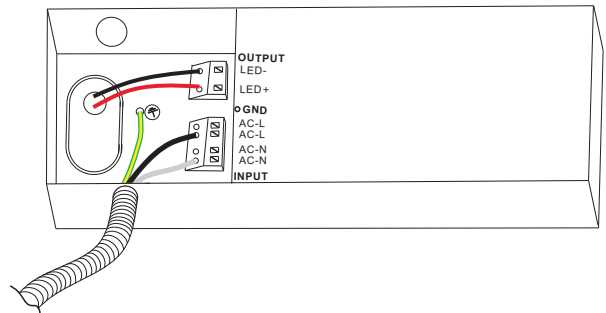
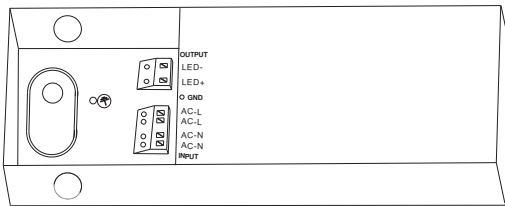

Installation Guide

Build-in

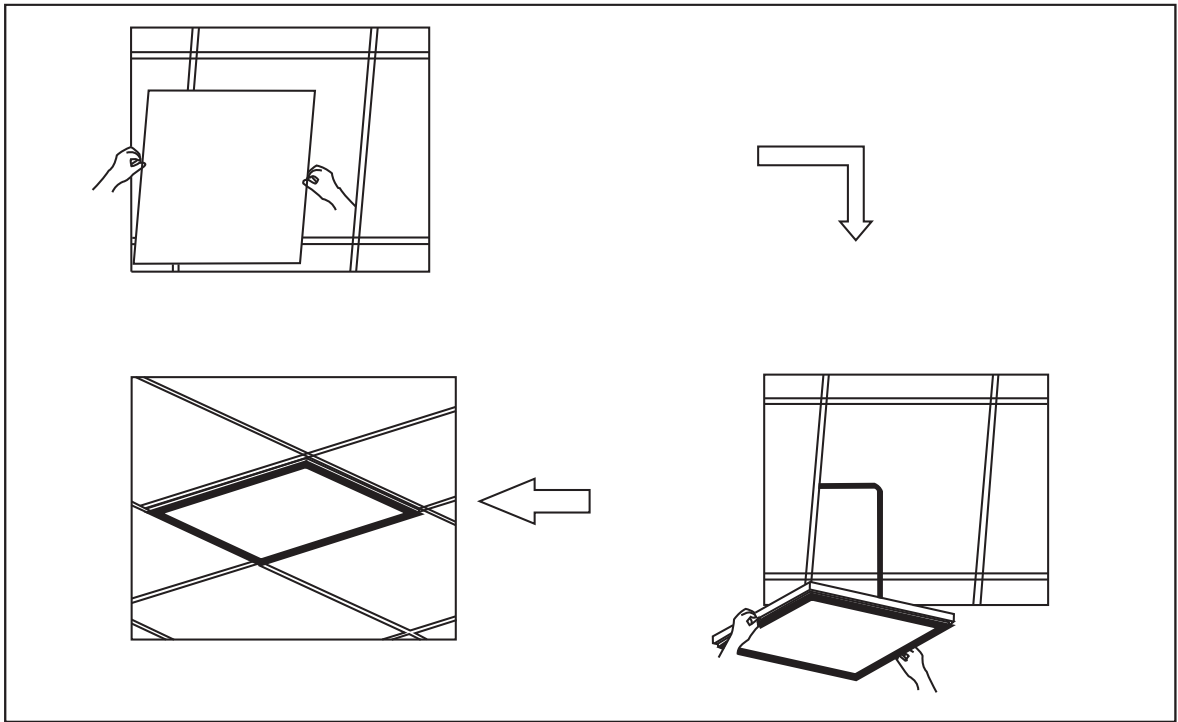

Suspended

According to the width of the panel light, drill 2 mounting holes on the mounting position

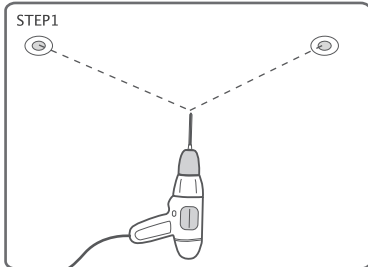

Button the panel light with the dog buckle of the equipped rope.

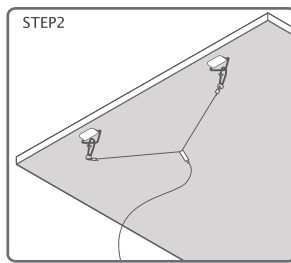

Twist off the rope grab device, and divide it into two parts: the upper cover and lower cover.

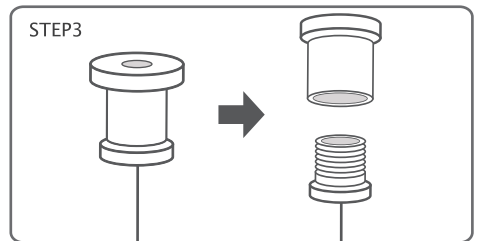

Fix the upper cover into prepared mounting holes with self-tapping screws (not included), and then twist on the lower cover.

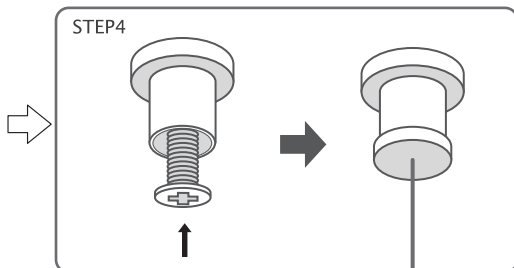

Connect LED panel light by the hook of suspension wire

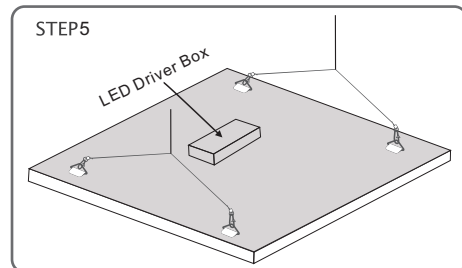

Surface Mount

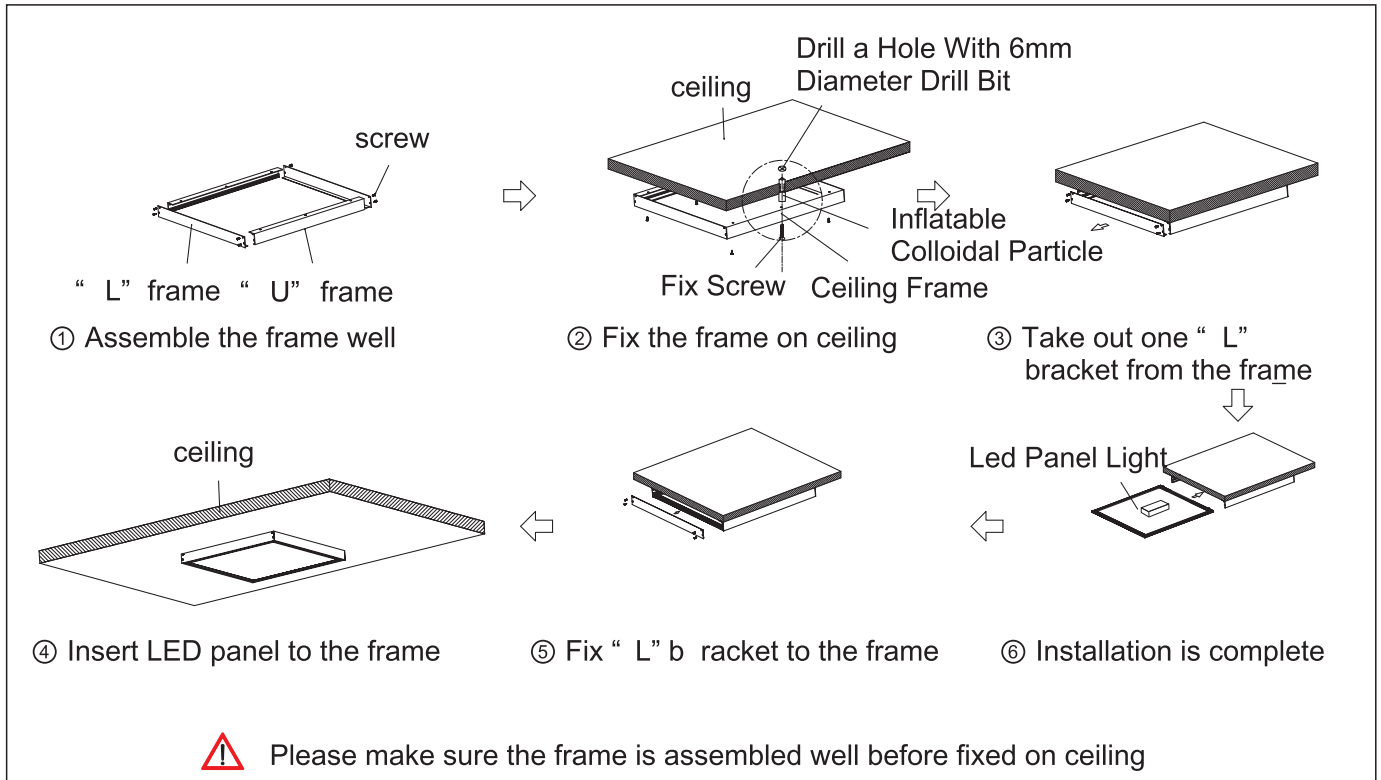

Package

Item	N.W.	CARTON SIZE(cm)	Qty.	G.W.
2X2 FT	3.8kg/pc	71X71X13	2pcs/CTN	9.3kg/CTN
1X4 FT	3.7kg/pc	131x41x13	2pcs/CTN	9.1kg/CTN
2X4 FT	6.8kg/pc	131X71X13	2pcs/CTN	16.8 kg/CTN

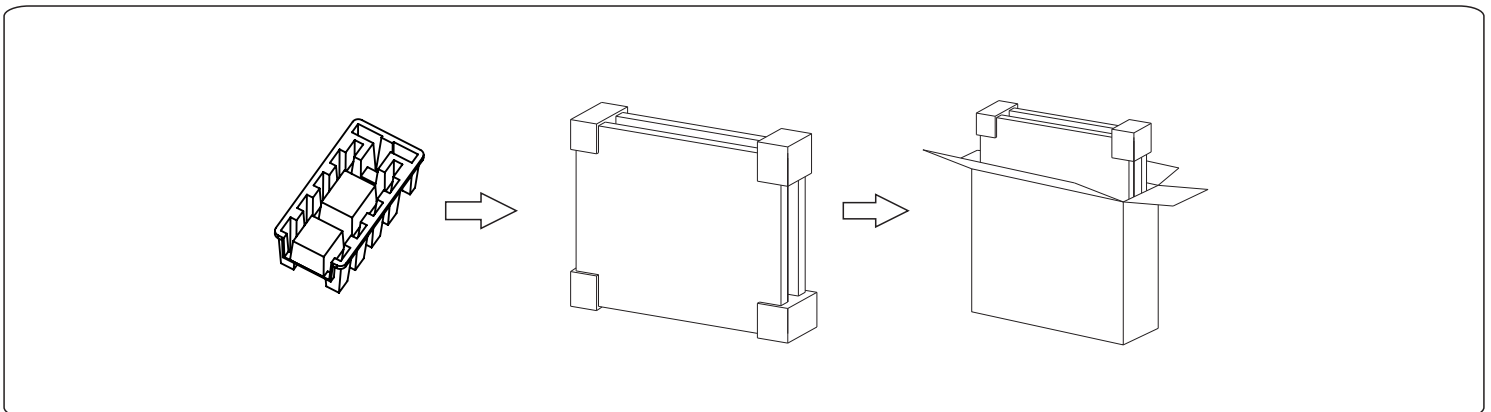

Warning

- Please use the product within the specified range of voltage.
- Please follow the correct installation steps to install the product, and do not touch when it is working.
- Please turn power off when installing and removing the products to avoid risk of electric shock.
- Please install the panel in the correct sized fixture.
- Do not look directly at LED light source for a long time.

Warranty

- 5 years warranty from the shipping date;
- MFR will replace all the failed products due to design/production quality during warranty period;
- MFR will bear all cost of maintains if the customer can help us to repair locally;
- MFR don't have the responsibility to compensate for any incorrect installation or artificial damage;
- MFR don't have the responsibility to compensate for damage occurred during the transit.

Application Reference

Application for most indoor area for Commercial Lighting, residential lighting and Industrial lighting, etc.

Warning and caution:

1. Don't use in completely enclosed fixture and damp area.
2. Used as safety or emergency lamps are not recommended.



family



office